

■ ARINC 429 ■ TRANSMITTER ■ RECEIVER ■
ANALYZER ■ FILTER ■ PATTERN GENERATOR ■ TESTER ■

1.0 FEATURES

- ✓ Bridges/converts between ARINC 429 bus with RS-232, RS-422, USB or Gig Ethernet.
- ✓ Platform independent – no software drivers.
- ✓ Up to 16/Rx & 16/Tx ARINC 429 channels
- ✓ Maximum throughput on all channels.
- ✓ Independent programmable bit rate.
- ✓ Command line interface (CLI) console
- ✓ Compatible with all terminal application software such as PuTTY, TeraTerm and similar.
- ✓ Human readable & coded data stream.
- ✓ Programmable time tag range, format and accuracy.
- ✓ Programmable AutoResponder for special protocol (such as ACARS).
- ✓ Programmable host Security Level Access.
- ✓ Programmable test pattern generators.
- ✓ Seven programmable error injection.
- ✓ Free cross-platform open source C/C++ software API library (Ai429API).
- ✓ Free GUI Terminal Application (AiTerm)
- ✓ Tabletop, DIN rail, panel and 1U of 19" rack mountable (up to 3 across standard 19" shelf).
- ✓ Lightweight: less than 1 lbs.
- ✓ Low power: less than 4 Watts.

2.0 APPLICATIONS

- ✓ Aircraft System Simulation (SIM)
- ✓ Automated Test System (ATS)
- ✓ Ground Support Equipment (GSE)
- ✓ Validation & Verification (V&V)
- ✓ Regression Testing (RT)
- ✓ Extended Stress Testing (ESS)
- ✓ System Diagnostic
- ✓ Software Development
- ✓ Flight Line Diagnostic
- ✓ Portable Tester
- ✓ New Product Development (R&D)

3.0 DESCRIPTIONS

The Ai429 is a cross-platform ARINC 429 bus interface, test and management device. It allows the user to interface, transmit & receive ARINC 429 data via any host computer. The host connection can be either Ethernet for speed or serial (USB or RS-232/RS-422) for convenience. Available in 4, 8, 12 and 16 transmit and receive channel pairs, the Ai429 products offer complete and unsurpassed features not found in any other competing products.

There are three classes of Ai429 device: transceiver/Ai429XCV, tester/Ai429TST and mixer/Ai429MXR.

The transceiver class (denoted by Ai429XCV) allows the user to monitor, transmit & receive multiple ARINC 429 data buses via cross-platform host interface (Ethernet/serial) using a free GUI, command line interface, scripts or a software API library. This is the basic product class.

The tester class (denoted by Ai429TST) provides all the features of the transceiver class with the added functionality of testing the buses by auto-generating user specified test patterns and injecting errors on command. This is the mid-range product class.

The mixer class (denoted by Ai429MXR) provides all the features of the transceiver and tester products with the added functionality of mixing, routing, filtering, merging & splitting ARINC 429 buses like a managed Ethernet switch. This is the highest product class.

This datasheet is for the Ai429TST Tester product class.

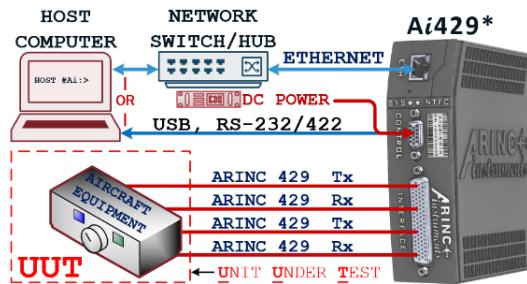

Tester Products Feature Comparison Table

	Ai429TST-	ES04	EU04	ES08	EU08	ES12	EU12	ES16	EU16
Receive / Transmit	4/4	4/4	8/8	8/8	12/12	12/12	-	-	-
Primary Host Port	ETHERNET								
Secondary Host Port	SERIAL	USB	SERIAL	USB	SERIAL	USB	-	-	-
Transmit Buffer	2048	2048	2048	2048	1024	1024	-	-	-
Switch / Hub / Filter	No	No	No	No	No	No	-	-	-
Pattern Generator	Yes	Yes	Yes	Yes	Yes	Yes	-	-	-
AutoResponder	Yes	Yes	Yes	Yes	Yes	Yes	-	-	-
Error Injection	Yes	Yes	Yes	Yes	Yes	Yes	-	-	-



SERIAL MODEL



USB MODEL



TABLE OF CONTENT

1.0	FEATURES	1	7.2.3	<i>The RECEIVE Port Architecture</i>	12
2.0	APPLICATIONS	1	7.3	FEATURE DESCRIPTION	12
3.0	DESCRIPTIONS	1	7.3.1	<i>Transmitter</i>	12
4.0	REVISION HISTORY	2	7.3.2	<i>Receiver</i>	12
5.0	PIN CONFIGURATION AND FUNCTIONS	3	7.3.3	<i>Loopback</i>	12
5.1	ETHERNET INTERFACE.....	3	7.3.4	<i>Time-Stamp / TIME-Tag</i>	13
5.2	SYSTEM STATUS LED	4	7.3.5	<i>Monitoring & Built-In-Test</i>	13
5.3	INTERFACE STATUS LED.....	4	7.3.6	<i>Security Access Level (SAL)</i>	13
5.4	SERIAL DEVICE MODEL CONTROL PORT PINOUT	5	7.3.7	<i>Transmit Scheduler or Rate Limiter</i>	13
5.5	SERIAL DEVICE MODEL CONFIGURATION STRAP TABLE	6	7.3.8	<i>AutoResponder</i>	13
5.6	USB DEVICE MODEL CONFIGURATION STRAP TABLE.....	6	7.3.9	<i>Configuration Flash</i>	13
5.7	DB78 INTERFACE CONNECTOR PINOUT	7	7.3.10	<i>Test Pattern Generator</i>	13
			7.3.11	<i>Transmit Data Error Injection</i>	13
6.0	SPECIFICATIONS	8	7.4	DEVICE FUNCTIONAL MODES	14
6.1	ABSOLUTE MAXIMUM RATINGS	8	8.0	APPLICATION AND IMPLEMENTATION	14
6.2	RECOMMENDED OPERATING TEMPERATURE.....	8	8.1	TEST/DEVELOPMENT SYSTEM APPLICATION.....	14
6.3	ELECTRICAL CHARACTERISTICS.....	8	9.0	MECHANICAL, PACKAGING AND MOUNTING	15
6.3.1	<i>Supply</i>	8	9.1	BENCH / TABLETOP	16
6.3.2	<i>ARINC 429 Input</i>	8	9.2	DIN RAIL MOUNT.....	16
6.3.3	<i>ARINC 429 Output</i>	9	9.3	PANEL MOUNT.....	16
6.3.4	<i>Serial Port</i>	9	9.4	SHELF/RACK MOUNT.....	17
7.0	ARCHITECTURE AND THEORY OF OPERATION	11	10.0	ORDERABLE INFORMATION	18
7.1	FUNCTIONAL BLOCK DIAGRAMS	11	11.0	MARKING	18
7.2	OVERVIEW	11	12.0	IMPORTANT NOTICE	19
7.2.1	<i>The Host Interface Port Architecture</i>	11			
7.2.2	<i>The TRANSMIT Port Architecture</i>	12			

4.0 REVISION HISTORY

NOTE: Page numbers for previous revisions may differ from page number in the current version.

Rev.	Descriptions / Reasons	Date
1.0	Initial Release	01/2021

5.0 PIN CONFIGURATION AND FUNCTIONS

The Ai429 comes with standard Gigabit Ethernet as a primary host connection and a serial port as secondary.

For serial models, the control port is a high density 15-pin D-sub female connect through which the device is powered, strapped and the alternate serial pins are available. The configuration strap pins are used to select the active host

connection port (Ethernet or Serial) as well as determine the device mode's (Admin/Host).

For USB models, the power connection is via a barrel connector, the serial connection is via a standard mini USB connector and the mode is set via a hex configuration switch – as shown below.

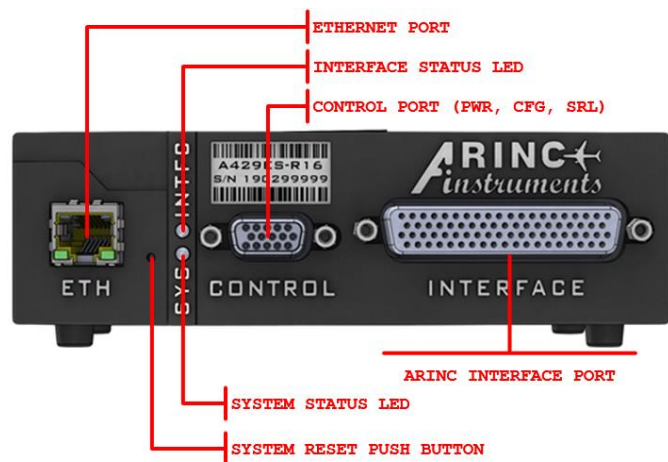

SERIAL DEVICE MODEL

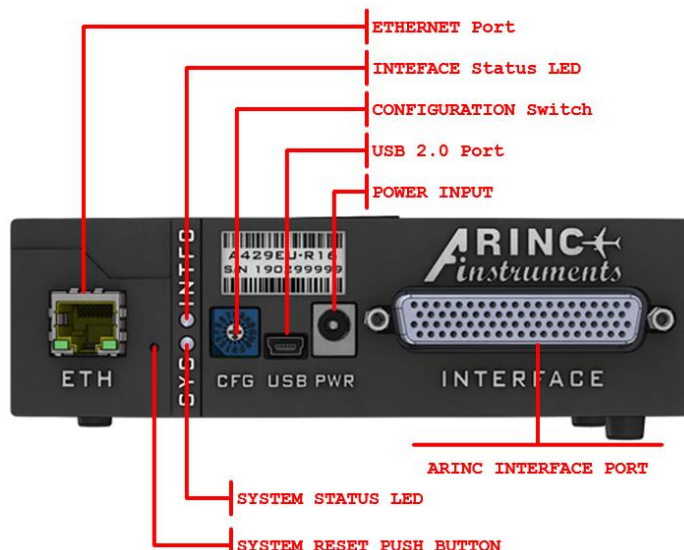

USB DEVICE MODEL

5.1 ETHERNET INTERFACE

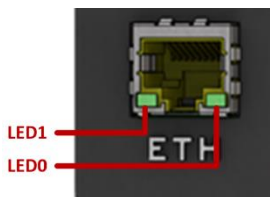

The Ethernet port is standard RJ-45. Supported protocols are DHCP, AutoIP, TCP/IP client and server with an embedded web server used for configuration. The Ethernet LEDs indicate the presence of an Ethernet link and also activity on the link.

Link	Activity	LED1 (Left)	LED0 (Right)
1000Mbps	No activity	Off	On
1000Mbps	Activity	Off	Blink
100Mbps	No activity	On	Off
100Mbps	Activity	Blink	Off
10Mbps	No activity	On	On
10Mbps	Activity	Blink	Blink
No Link	-	Off	Off

5.2 SYSTEM STATUS LED



The System LED is tricolor. Blinking conveys activity and color indicate status.

Host SYSTEM Status	LED Color
Good	Green
Warning	Orange
Error	Red

Host SYSTEM Activity	LED Activity
No activity	On
Activity	Blink
Offline	Off

5.3 INTERFACE STATUS LED



The Interface LED is tricolor. Blinking conveys activity and color indicate status. One LED to reflect the status of all the ARINC 429 interfaces.

ARINC 429 INTERFACE Status	LED Color
Good	Green
Warning	Orange
Error	Red

ARINC 429 INTERFACE Activity	LED Activity
No activity	On
Activity	Blink
Offline	Off

5.4 SERIAL DEVICE MODEL CONTROL PORT PINOUT

The table shows the serial device mode's **CONTROL** port pinout along with suggested DB9 connector pinouts.

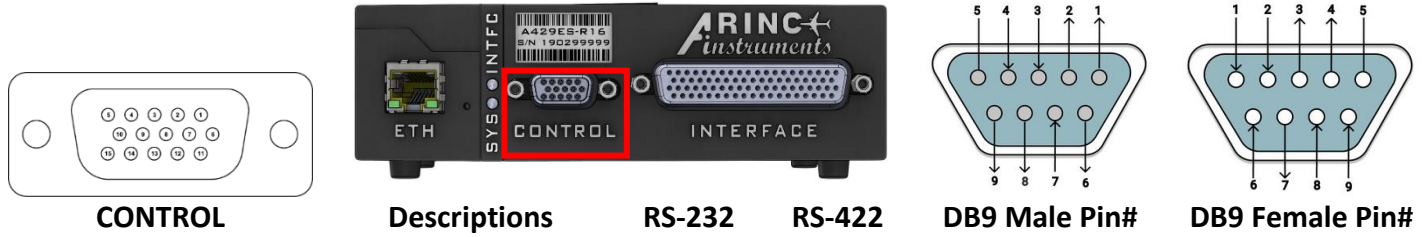

CONTROL	Descriptions	RS-232	RS-422	DB9 Male Pin#	DB9 Female Pin#
2	Transmitter Output 1	TXD	TX-	3	2
3	Transmitter Output 2	RTS	TX+	7	8
7	Receiver Input 1	RXD	RX+	2	3
8	Receiver Input 2	CTS	RX-	8	7
13	Signal Ground	GND	GND	5	5
5, 10, 15	POWER	+10 to +36 VDC			
6, 11, 1	POWER RTN	GROUND / POWER RETURN			
12	CFG STRAP[0]	See Serial Device Model Configuration Strap Table.			
14	CFG STRAP[1]				
4	CFG STRAP[2]				
9	CFG STRAP[3]				

**CONTROL PORT CABLE WITH
DSUB9 MALE RS-232 SERIAL**

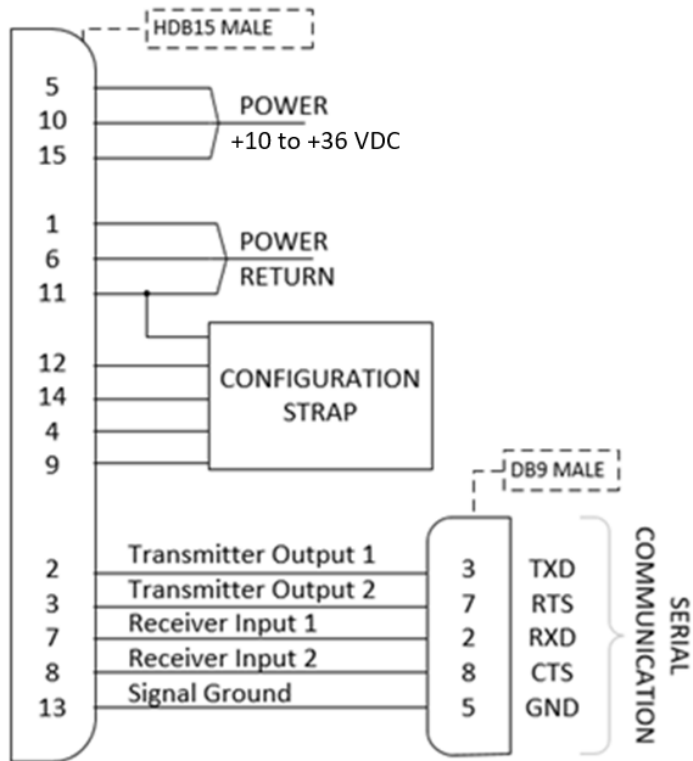

**CONTROL PORT CABLE WITH
DSUB9 FEMALE RS-232 SERIAL**

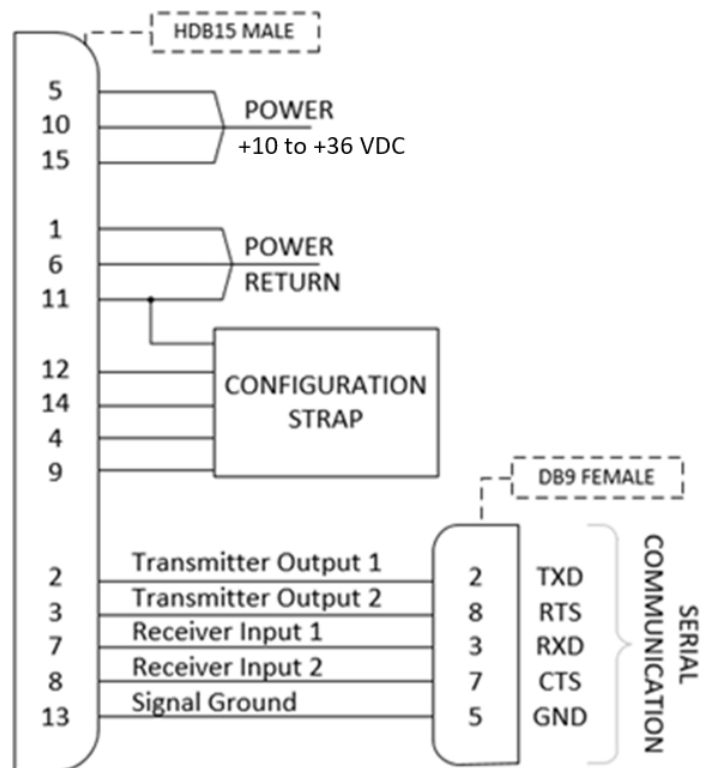

5.5 SERIAL DEVICE MODEL CONFIGURATION STRAP TABLE

The table below shows the serial device model's mode and active host interface port based on the Control port configuration pin strapping.

*CFG STRAP[3:0]	ACTIVE BUS	DEVICE MODE	DESCRIPTIONS
ZZZZ	Ethernet	ADMIN	10/100/1000Based-T Ethernet Admin, with TCP/IP – full access.
ZZZG	Ethernet	HOST	10/100/1000Based -T Ethernet Host, with TCP/IP – programmable restricted access.
ZZGZ	Ethernet	HOST LOCK	10/100/1000Based -T Ethernet Host, with TCP/IP – fixed access restriction.
ZZGG	-	-	RESERVED
ZGZZ	RS-232	ADMIN	RS-232 Admin, forced 9600 baud with no flow control – full access.
ZGZG	RS-232	HOST	RS-232 Serial Host. Up to 1Mbps – programmable restricted access.
ZGGZ	RS-232	HOST LOCK	RS-232 Serial Host. Up to 1Mbps – fixed access restriction.
ZGGG	-	-	RESERVED
GZZZ	RS-422	ADMIN	RS-422 Admin, forced 9600 baud with no flow control – full access.
GZZG	RS-422	HOST	RS-422 Host Serial. Up to 15Mbps – programmable restricted access.
GZGZ	RS-422	HOST LOCK	RS-422 Host Serial. Up to 15Mbps – fixed access restriction.
GZGG	-	-	RESERVED
****	ISOLATED	NONE	ISOLATED – No Host Interface.

Z := Floating / Not Connected

G := Grounded / Shorted to GND or POWER RTN

* The “CFG STRAP[3:0]” column represents pin number [9, 4, 14, 12] from the serial model's **CONTROL** port connector.

5.6 USB DEVICE MODEL CONFIGURATION STRAP TABLE

The table below shows the USB device model's mode based on the front panel configuration switch.

*CFG SW VALUE	ACTIVE BUS	DEVICE MODE	DESCRIPTIONS
0	Ethernet	ADMIN	10/100/1000Based-T Ethernet Admin, with TCP/IP – full access.
1	Ethernet	HOST	10/100/1000Based -T Ethernet Host, with TCP/IP – programmable restricted access.
2	Ethernet	HOST LOCK	10/100/1000Based -T Ethernet Host, with TCP/IP – fixed access restriction.
3	-	-	RESERVED
4	USB	ADMIN	USB Admin, forced 9600 baud with no flow control – full access.
5	USB	HOST	USB Serial Host. Up to 1Mbps – programmable restricted access.
6	USB	HOST LOCK	USB Serial Host. Up to 1Mbps – fixed access restriction.
7	-	-	RESERVED
8-F	ISOLATED	NONE	ISOLATED – No Host Interface.

* The “CFG SW VALUE” column represents the hex switch value from the USB model's front panel.

5.7 DB78 INTERFACE CONNECTOR PINOUT

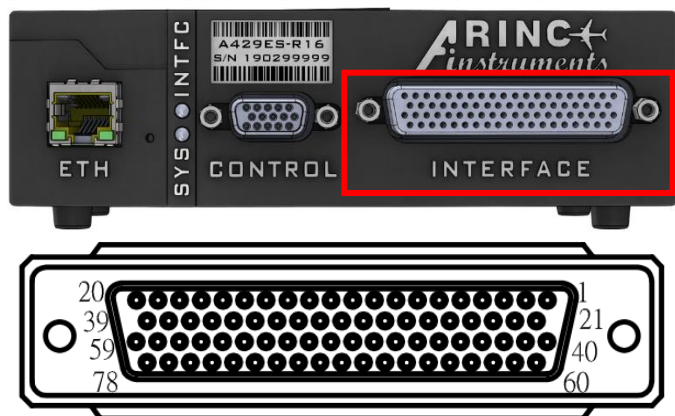

PIN#	SIGNALS
59	SIGNAL GROUND
20	SIGNAL GROUND
78	N/C
58	N/C
39	N/C
19	N/C
77	N/C
57	N/C
38	N/C
18	N/C
74	ARINC 429 XMT (A) CH16
54	ARINC 429 XMT (B) CH16
76	ARINC 429 RCV (A) CH16
56	ARINC 429 RCV (B) CH16
35	ARINC 429 XMT (A) CH15
15	ARINC 429 XMT (B) CH15
37	ARINC 429 RCV (A) CH15
17	ARINC 429 RCV (B) CH15
73	ARINC 429 XMT (A) CH14
53	ARINC 429 XMT (B) CH14
75	ARINC 429 RCV (A) CH14
55	ARINC 429 RCV (B) CH14
34	ARINC 429 XMT (A) CH13
14	ARINC 429 XMT (B) CH13
36	ARINC 429 RCV (A) CH13
16	ARINC 429 RCV (B) CH13
70	ARINC 429 XMT (A) CH12
50	ARINC 429 XMT (B) CH12
72	ARINC 429 RCV (A) CH12
52	ARINC 429 RCV (B) CH12
31	ARINC 429 XMT (A) CH11
11	ARINC 429 XMT (B) CH11
33	ARINC 429 RCV (A) CH11
13	ARINC 429 RCV (B) CH11
10	ARINC 429 XMT (A) CH10

PIN#	SIGNALS
29	ARINC 429 XMT (B) CH10
71	ARINC 429 RCV (A) CH10
51	ARINC 429 RCV (B) CH10
49	ARINC 429 XMT (A) CH9
68	ARINC 429 XMT (B) CH9
32	ARINC 429 RCV (A) CH9
12	ARINC 429 RCV (B) CH9
69	SIGNAL GROUND
30	SIGNAL GROUND
7	ARINC 429 XMT (A) CH8
26	ARINC 429 XMT (B) CH8
9	ARINC 429 RCV (A) CH8
28	ARINC 429 RCV (B) CH8
46	ARINC 429 XMT (A) CH7
65	ARINC 429 XMT (B) CH7
48	ARINC 429 RCV (A) CH7
67	ARINC 429 RCV (B) CH7
6	ARINC 429 XMT (A) CH6
25	ARINC 429 XMT (B) CH6
8	ARINC 429 RCV (A) CH6
27	ARINC 429 RCV (B) CH6
45	ARINC 429 XMT (A) CH5
64	ARINC 429 XMT (B) CH5
47	ARINC 429 RCV (A) CH5
66	ARINC 429 RCV (B) CH5
3	ARINC 429 XMT (A) CH4
22	ARINC 429 XMT (B) CH4
5	ARINC 429 RCV (A) CH4
24	ARINC 429 RCV (B) CH4
42	ARINC 429 XMT (A) CH3
61	ARINC 429 XMT (B) CH3
44	ARINC 429 RCV (A) CH3
63	ARINC 429 RCV (B) CH3
2	ARINC 429 XMT (A) CH2
21	ARINC 429 XMT (B) CH2
4	ARINC 429 RCV (A) CH2
23	ARINC 429 RCV (B) CH2
41	ARINC 429 XMT (A) CH1
60	ARINC 429 XMT (B) CH1
43	ARINC 429 RCV (A) CH1
62	ARINC 429 RCV (B) CH1
40	SIGNAL GROUND
1	SIGNAL GROUND

6.0 SPECIFICATIONS

6.1 ABSOLUTE MAXIMUM RATINGS

Over operating free-air temperature range (unless otherwise noted)

		MIN	MAX	UNIT
V_{IN}	Maximum Supply voltage	0	38	V
	ARINC input voltage	-120		120
T_A	Maximum operating ambient temperature	0	70	°C
T_J	Maximum storage temperature	-40	85	°C

6.2 RECOMMENDED OPERATING TEMPERATURE

		MIN	NOM	MAX	UNIT
V_{IN}	Supply voltage	10		36	V
T_A	Operating ambient temperature	0		70	°C
T_J	Storage temperature	-40		85	°C

6.3 ELECTRICAL CHARACTERISTICS

6.3.1 SUPPLY

T_A = Operating Temperature Range (unless or otherwise specified).

PARAMETER		TEST CONDITIONS	MIN	NOM	MAX	UNIT
V_{IN}	Supply voltage		10	24	36	V
I_{IN}	Supply current	$V_{IN} = 10V$		326		mA
		$V_{IN} = 12V$		276		
		$V_{IN} = 15V$		220		
		$V_{IN} = 20V$		165		
		$V_{IN} = 24V$		140		
		$V_{IN} = 28V$		121		
		$V_{IN} = 32V$		108		
		$V_{IN} = 36V$		---		
P_D					4	W

6.3.2 ARINC 429 INPUT

T_A = Operating Temperature Range (unless or otherwise specified).

PARAMETER		TEST CONDITIONS	MIN	TYP	MAX	UNIT
V_{DIN}	Input voltage ONE or ZERO	Differential input voltage	6.5	10	13	V
V_{NIN}	NULL	Differential input voltage			2.5	V
V_{VOM}	Common mode	With respect to GND			±5	V
R_{DIFF}	Input resistance INA to INB	Supplies floating/off	30	75		KΩ
R_{SUP}	Input to GND	Supplies floating/off	19	40		KΩ
V_{HIS}	Input hysteresis		0.5	1.0		V
C_{AD}	Input capacitance ARINC differential			5	10	pF
C_{AS}	ARINC single ended to Vss				10	pF



6.3.3 ARINC 429 OUTPUT

T_A = Operating Temperature Range (unless or otherwise specified).

PARAMETER			TEST CONDITIONS	MIN	NOM	MAX	UNIT
V _{DIFF1}	Output voltage	ONE	No load differential output voltage	9	10	11	V
V _{DIFF0}		ZERO	No load differential output voltage	-11	-10	-9	V
V _{DIFFN}		NULL	No load differential output voltage	-0.5	0	0.5	V
V _{DOUT}		ONE or ZERO	No load, Ref. to GND	4.5	5	5.5	V
V _{NOUT}		NULL	No load, Ref. to GND	-0.25	0	0.25	V
Z _{OUT}	Output impedance				37.5		Ω
T _{TRANS}	Transition times	High to low	High Speed	1.0	1.5	2.0	μs
		Low to high	High Speed	1.0	1.5	2.0	μs
		High to low	Low Speed	5.0	10.0	15.0	μs
		Low to high	Low Speed	5.0	10.0	15.0	μs

6.3.4 SERIAL PORT
6.3.4.1 RS-232/RS-422 ESD PROTECTION

			VALUE	UNIT
V _(ESD)	TX Output & RX Input Pins	IEC 61000-4-2 Airgap	±15	kV
		IEC 61000-4-2 Contact	±8	kV
		Human Body Model (HBM)	±15	kV

6.3.4.2 RS-232 TRANSMIT & RECEIVE PINS

T_A = Operating Temperature Range (unless or otherwise specified).

PARAMETER		TEST CONDITIONS	MIN	NOM	MAX	UNIT
RS-232 SINGLE-ENDED RECEIVER INPUTS						
V _{IN}	Input Voltage Range		-15		+15	V
V _{IL}	Input Threshold Low		0.6	1.5		V
V _{IH}	Input Threshold High			1.5	2.0	V
V _{HYS}	Input Hysteresis			0.5		V
R _{IN}	Input Resistance	-15V ≤ V _{IN} ≤ +15V	3	5	7	kΩ
RS-232 SINGLE-ENDED TRANSMITTER OUTPUTS						
V _{OUT}	Output Voltage Swing	Outputs loaded with 3kΩ to Gnd	±5.0	±5.5		V
R _{OFF}	Output Power Off Impedance	Power off	300	10M		Ω
I _{SC}	Output Short Circuit Current	V _{OUT} = 0V		±30	±60	mA

6.3.4.3 RS-422 TRANSMIT & RECEIVE PINS

T_A = Operating Temperature Range (unless or otherwise specified).

PARAMETER		TEST CONDITIONS	MIN	NOM	MAX	UNIT
RS-422 DIFFERENTIAL RECEIVER INPUTS						
R _{IN}	Receiver Input Resistance	-7V ≤ V _{CM} ≤ +12V	96			kΩ
I _{IN}	Receiver Input Current	V _{IN} = +12V			125	μA
		V _{IN} = -7V			-100	μA
V _{TH}	Receiver Differential Threshold Voltage	-7V ≤ V _{CM} ≤ +12V	-200	-125	-50	mV
ΔV _{TH}	Receiver Input Hysteresis			25		mV
RS-422 DIFFERENTIAL DRIVER INPUTS						
V _{OD}	Differential Driver Output	-7V ≤ V _Y or V _Z ≤ +12V (Figure 2)	1.5			V
		RL = 100 Ω (Figure 1)	2		3.3	V
ΔV _{OD}	Change in Magnitude of Differential Output Voltage	RL = 54 Ω or 100 Ω (Figure 1)			0.2	V
V _{CM}	Driver Common Mode Output Voltage	RL = 54 Ω or 100 Ω (Figure 1)			3	V
ΔV _{CM}	Change In Magnitude of Common Mode Output Voltage	RL = 54 Ω or 100 Ω (Figure 1)			0.2	V
I _{OSD}	Driver Output Short Circuit Current	-7V ≤ V _Y or V _Z ≤ +12V (Figure 3)			±250	mA
I _o	Driver Output Leakage Current	V _Y or V _Z = -7V or +12V,			±125	mA

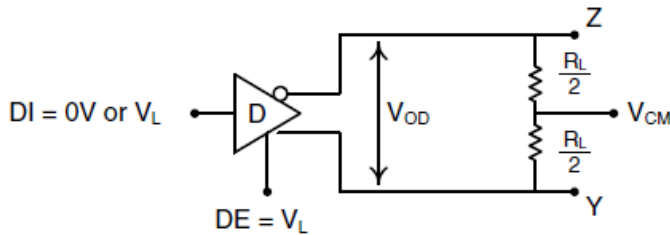

FIGURE 1. RS-422 DIFFERENTIAL DRIVER OUTPUT VOLTAGE

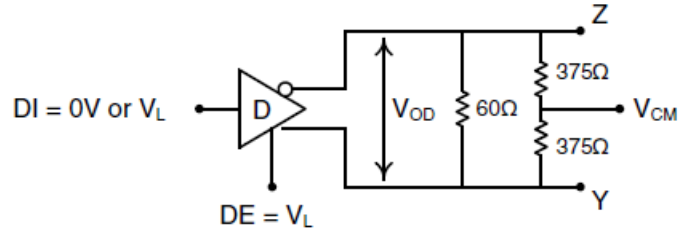

FIGURE 2. RS-422 DIFFERENTIAL DRIVER OUTPUT VOLTAGE OVER COMMON MODE

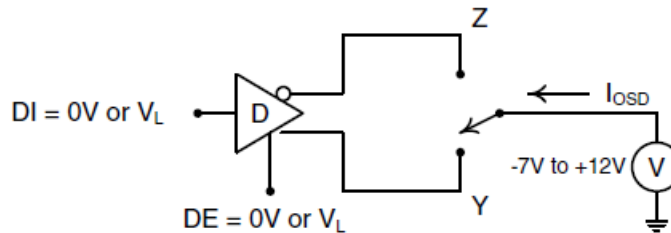
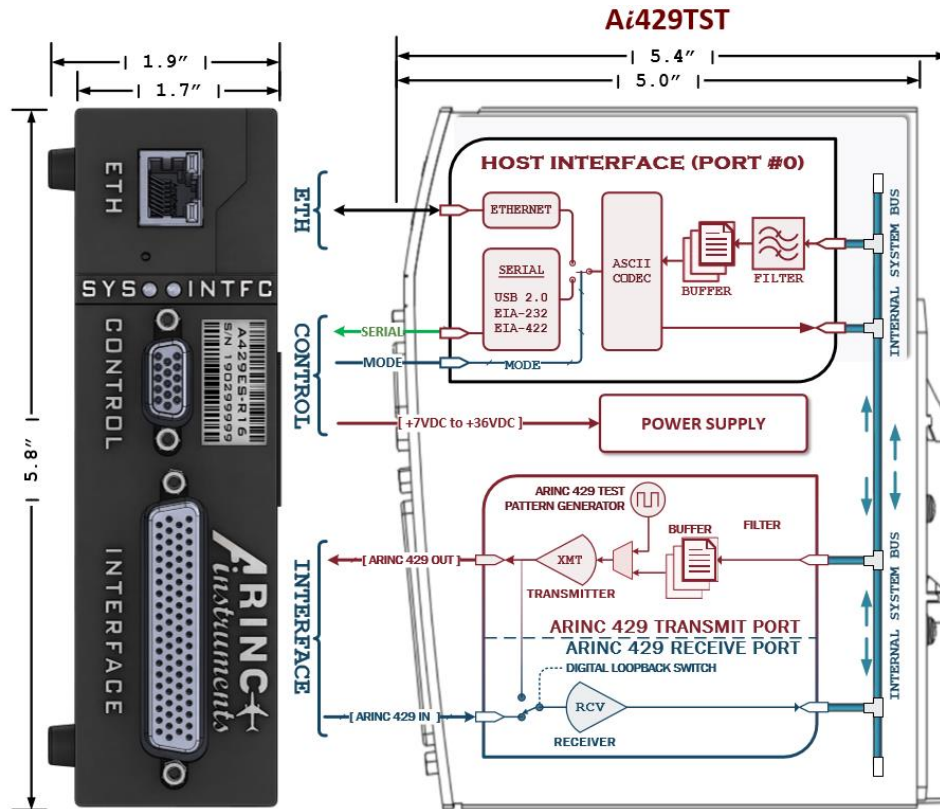

FIGURE 3. RS-422 DRIVER OUTPUT SHORT CIRCUIT CURRENT

7.0 ARCHITECTURE AND THEORY OF OPERATION

7.1 FUNCTIONAL BLOCK DIAGRAMS



7.2 OVERVIEW

The Ai429 is a cross-platform ARINC 429 bus interface, test and management device. It allows the user to transmit, receive, monitor, inject errors, generate test data, mix, route, merge, split, repeat and filter ARINC 429 data buses under the control of any host computer. The host connection can either be Ethernet for speed or serial for convenience. The serial connection is USB for USB device models or RS-232/RS-422 for serial device models. To achieve cross-platform compatibility, device uses existing Ethernet, RS-232, RS-422 or USB ports for connectivity and communicates strictly in structured ASCII texts.

The system's architecture is composed of one Host Interface, multiple transmit ports, multiple receive ports and one Internal System Bust for internal interconnect.

7.2.1 THE HOST INTERFACE PORT ARCHITECTURE

The Host Interface block (also referred to as Port #0) is responsible for interfacing to the host computer. It translates commands/data from the host to the device and vice versa. This module offers two types of connections: a primary connection which is the Ethernet, and a secondary which is the serial.

The configuration strapping determines the device's mode (Admin or Host) as well as the active host connection (serial or Ethernet).

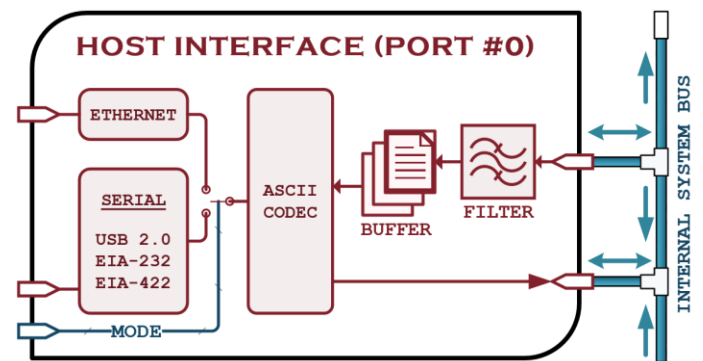

There is an ASCII Interface Converter module attached to the Internal System Bus. This module has two functions: convert internal data from the Internal System Bus to a structured ASCII string to be sent to the currently active host port (Ethernet/Serial/USB), and convert commands from the currently active host port to the proper binary format and place them on the Internal System Bus. This is essentially an ASCII CODEC (Coder / DECoder).

7.2.2 THE TRANSMIT PORT ARCHITECTURE

The transmit port block diagram is shown below. It is composed of a Transmitter, a Pattern Generator, a Buffer, and a Filter. We're first going to explain each block separately, then we'll functionally put it all together.

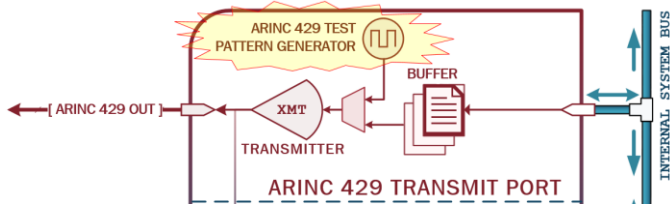

The Transmitter block takes the data, modulates it into a proper ARINC 429 waveform timing and sends it out. The Buffer is simply a FIFO queue that holds data to be transmitted. The Pattern Generator can generate timing accurate test patterns on command.

7.2.3 THE RECEIVE PORT ARCHITECTURE

The ARINC 429 receive port architecture is shown in the figure below. We see that it has a Receiver and a Digital Loopback Switch.

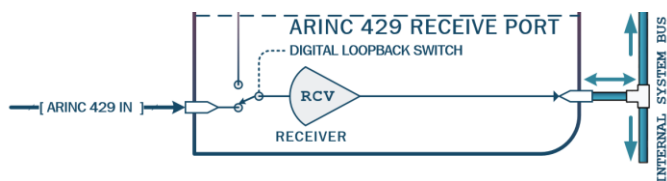

The Receiver block basically receives and demodulate the ARINC 429 signals. Its main function is to demodulate the signal timings and levels. The host system sets up each Receive port to block/pass a certain speed/parity. If the received word matches the configured speed and parity configuration, it is passed on to the ISB – otherwise it is rejected. If the data was accepted, it is broadcasted on the ISB for the host along with all the other interface to use.

There is a Port Analysis feature that generally remains dormant. When enabled, it sets an arbitrary one second time interval window during which it counts how many received data words were rejected and accepted. A word can be rejected if it does not meet the required speed and parity settings. Once that time interval has expired, it sends that analysis information to the host computer via the Internal System Bus and resets the count for the next one-second time interval. The host computer can monitor how many receive words were accepted and rejected at each passing second.

There is no data label or SDI filter in the receive port architecture. Any data that is properly received is made available to all the other ports. It is the other ports that decides if they want it or not – this means that the other ports have their own selection filter – as previously shown in the transmit & host interface port sections.

There is no receive FIFO/buffer at the receive port. The reason for this is that the Internal System Bus medium is so

fast that there is never any need for a receive buffer – but transmit output is a different story.

7.3 FEATURE DESCRIPTION

- ✓ Receive & Transmit ARINC 429 data.
- ✓ Monitor multiple ARINC 429 buses simultaneously.
- ✓ Generate ARINC 429 test data patterns.
- ✓ Inject up to seven different error types into the transmitted data output(s).
- ✓ Repeat/retransmit received data at a same/different rate.
- ✓ Retain internal configuration through power cycles without the need for the host system – standalone operation.
- ✓ Perform all or any combinations of the above functions simultaneously – without any degradation whatsoever.

7.3.1 TRANSMITTER



The Ai429 can transmits up to 16 simultaneous 429 outputs. Each output is completely independent from the others and can be set to various speeds, transmit schedules, output pin swap, parity settings and error injections. User can even send data straight from any terminal's command line.

7.3.2 RECEIVER



The Ai429 can receive up to 16 simultaneous 429 inputs. Each channel's input pin pair can also be swapped, and the speed can be automatically detected. Once a 429 word is received, it can be routed to other outputs including the host computer. The host can request for the system to filter which port, labels and SDIs to view/block, as well as decode and format the received data to be visually interpreted by the user.

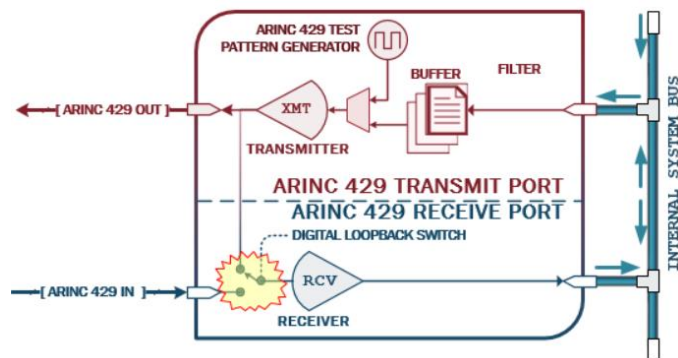

7.3.3 LOOPBACK

Every output is naturally paired with its complimentary input (transmit port #1 is naturally paired with receive port #1) – this means that the ports can be set for digital loopback where the host computer can monitor everything the transmitter is sending.



The Digital Loopback Switch allows the Receiver port to disconnect from the device's input and connect to the complementary Transmit port's output. Through this, the host computer can check what the transmitter is sending out.

7.3.4 TIME-STAMP/TIME-TAG

HOST  **TIME**  All data & status going to the Host computer can be optionally time tagged in one of three modes (message count, elapsed, delta time) and in two formats (hex or decoded). Timing resolution can be set from one second down to one microsecond with ranges spanning from seconds to years. See sample time stamp format below.

RAW/HEX:	+7 [FFFFFFFFFFFFFFFF]
MESSAGE COUNT:	[9 999 999 999 999 999]
DELTA/ELAPSED:	[99y:364d:23h:59m:59.999999s]



7.3.5 MONITORING & BUILT-IN-TEST



All ports (transmitters and receivers) generate status, warnings, errors and sometimes diagnostic information (when enabled) that can be observed for analysis and troubleshooting. Any port can be monitored by the host computer/interface.

When Port Analysis feature enabled, it sets a one second arbitrary time window during which it counts how many data words accepted or rejected during that time interval. Once that time window has expired, it sends that information to the host system and resets the count for another one-second time window. The result is that the host can monitor how many words were accepted & rejected for each passing second. By this mean, any port's performance and burden can be monitored by the host computer.

7.3.6 SECURITY ACCESS LEVEL (SAL)

HOST   The Ai429 host port provides a hardware-level Security Access Level (SAL) resource restriction control. This feature, when enabled, restricts the host computer from certain pre-selected internal resources – preventing test script/software from inadvertently modifying internally restricted settings. An error message is returned when a prohibited access is attempted.

This also serves to enhance the security profile of the device because it cannot be hacked. Why? The security is embedded in the hardware. The user must physically change the device's mode from Host to Admin before changing the SAL access configuration.

7.3.7 TRANSMIT SCHEDULER OR RATE LIMITER



The Ai429 transmitter can be set to send 429 data on a preset repeating time interval of up to 16 seconds at a 1 microsecond increment. This effectively sets a transmit schedule which also limits the output throughput. It thereby creates an evenly spaced/distributed 429 data output. This feature is often used to schedule transmission because its accuracy is much greater than the host computer.

7.3.8 AUTORESPONDER





Selected ports are equipped with an AutoResponder feature which monitors the corresponding receiver port for a pre-programmed trigger word. When the trigger word is received, the transmitter automatically sends out a pre-programmed response word. A mask register is available to pick which bits in the trigger word matters or not.

7.3.9 CONFIGURATION FLASH

All Ai429 internal configuration settings can be flashed upon command. An internally flashed configuration can be retrieved upon command or automatically on power-on reset.

7.3.10 TEST PATTERN GENERATOR

 **A429**  **UUT** Each output is equipped with three pattern generators controlling the data, label and SDI ARINC fields. When enabled, each generator can be independently set for fix, increment, random or walking/shifting pattern mode. The generated ARINC 429 word patterns can be transmitted at a programmed interval for testing.

7.3.11 TRANSMIT DATA ERROR INJECTION

HOST    Each output can inject up to seven types of errors into the output data by selectively corrupting certain transmit modulation parameters.

7.4 DEVICE FUNCTIONAL MODES

The Ai429 has two functional modes: Admin and Host mode. The device's mode is set by setting the configuration strap pins (for serial models) or the front panel hex switch (for USB models).

For Admin mode, the device does not load the internally saved configuration during power-on reset and it also grants the host computer unrestricted access to internal resource. Also, under Admin mode, the serial port always come up in the default configuration setting.

For Host mode, the device always loads the internally saved configuration during power-on reset and it also grants the host computer restricted access to internal resource based on the saved user defined setting during the Admin mode.

The internally saved configuration can be loaded by the user/host computer at any time upon command.

Unless the user desires restricted access and/or preconfigured setting upon power-on reset, the Admin mode is generally the default mode.

8.0 APPLICATION AND IMPLEMENTATION

Typical application of the Ai429 is numerous.

8.1 TEST/DEVELOPMENT SYSTEM APPLICATION



In this application the Ai429 bridges the host computer with the UUT (Unit Under Test) and allows exchange/bridging of multiple ARINC 429 buses. The host system can be running scripts, software or a simple terminal application and will require no driver.

The Ai429 system can be made to also automatically generate test data patterns to test the UUT. The timing of the test patterns can be very accurate down to one microsecond resolution.

This is the most common setup.

9.0 MECHANICAL, PACKAGING AND MOUNTING

The Ai429 is mechanically designed to accommodate at least four basic physical mounting types:

- ✓ Table mount using Rubber Feet sticker.
- ✓ Standard DIN rail mount.
- ✓ Standard 1U rack mount with up to 3 devices across one standard 19" shelf.
- ✓ Panel Mount – using the four bottom 6-32 threaded holes.

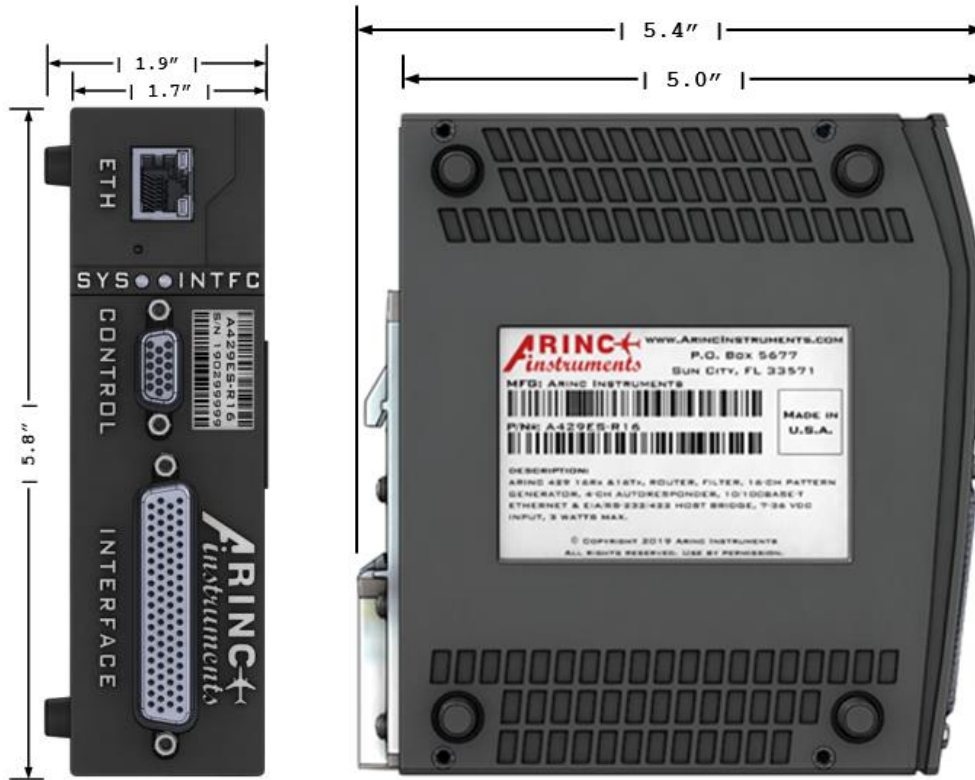

Model	Pounds Maximum	Grams Maximum
USB MODELS	1.0 lbs. max	0.454 kilograms max
SERIAL MODELS	1.0 lbs. max	0.454 kilograms max

9.1 BENCH/TABLETOP

All devices come with a set of four rubber feet stickers. There are four recessed holes at the bottom for placement as shown in the figure below.

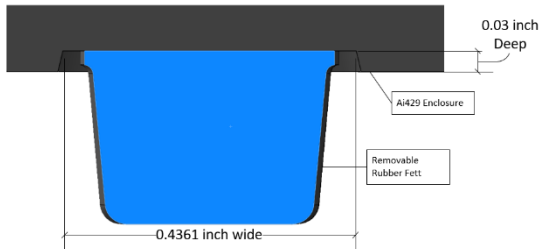
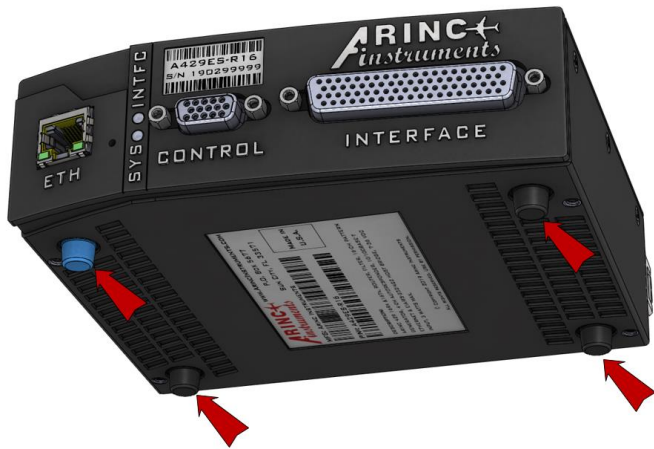

9.2 DIN RAIL MOUNT

Every device has a standard DIN rail adapter located in the rear as shown below.

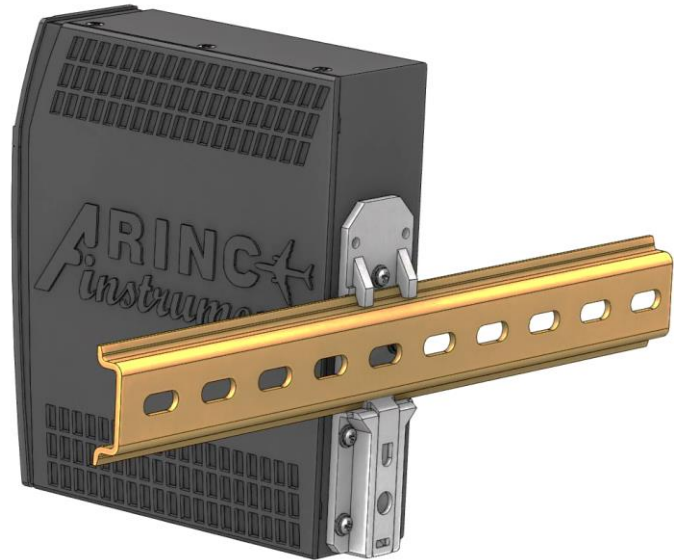

9.3 PANEL MOUNT

There are four threaded screw holes located under the device. The figure below shows the product with an outline showing the locations of the four holes.

The holes are 6-32 threaded screw holes with a maximum depth of 0.35 in. The threaded depth is 0.25 inch.

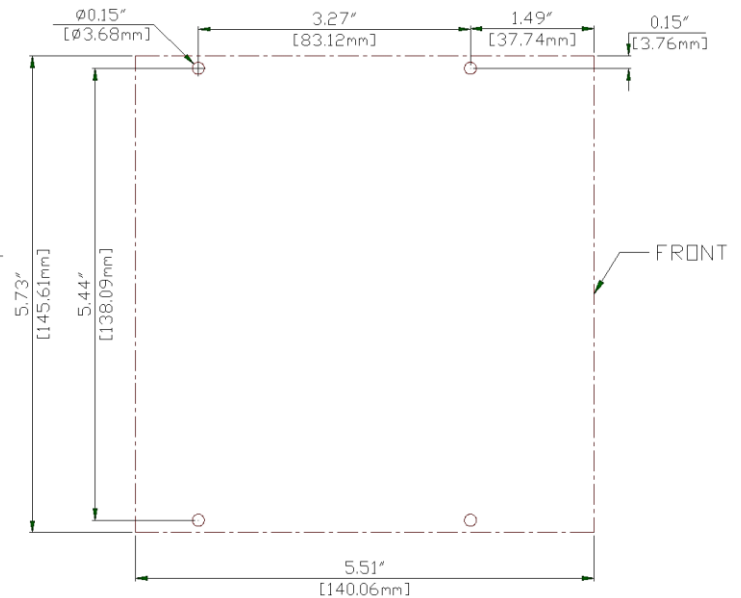
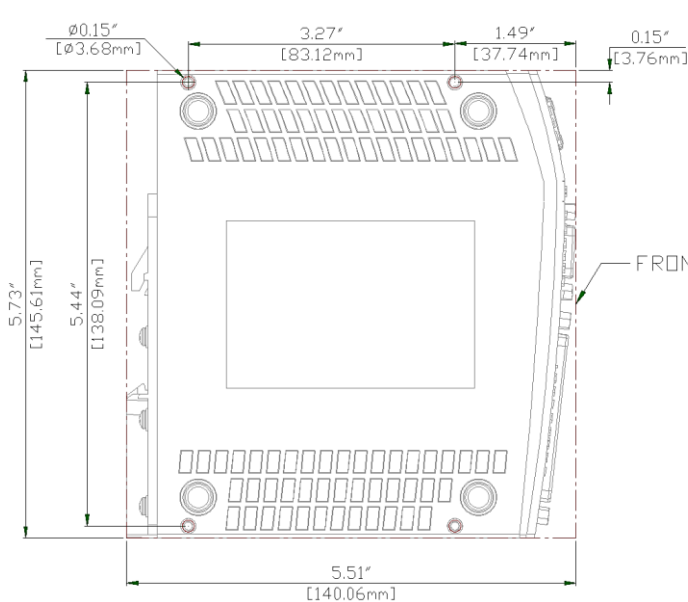

9.4 SHELF/RACK MOUNT

The device was designed to rack mounted on a standard 1U 19 inches shelf. The device's width is such that three units can be stacked on one shelf as shown below.

STANDARD 19" 1U SHELF WITH 3 AI429 – FRONT VIEW

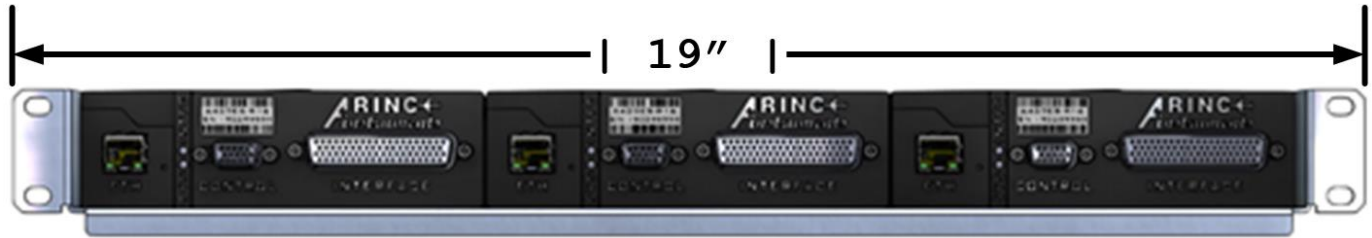

STANDARD 19" 1U SHELF WITH 3 AI429 – TOP VIEW

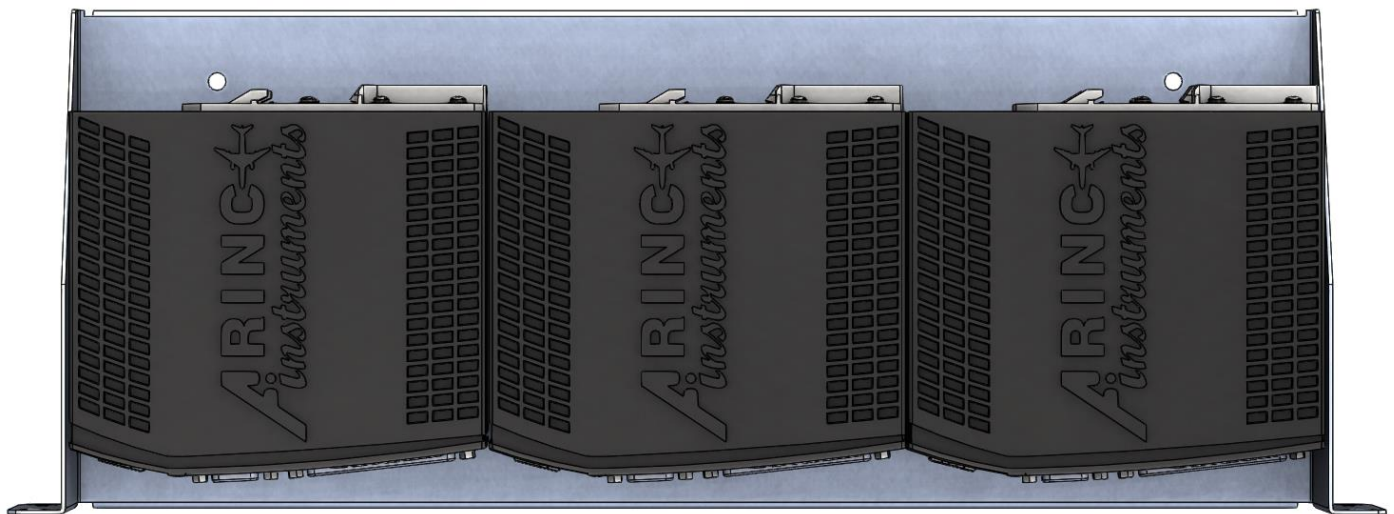

STANDARD 19" SHELF DRILL LOCATION FOR 3 AI429 - TOP VIEW

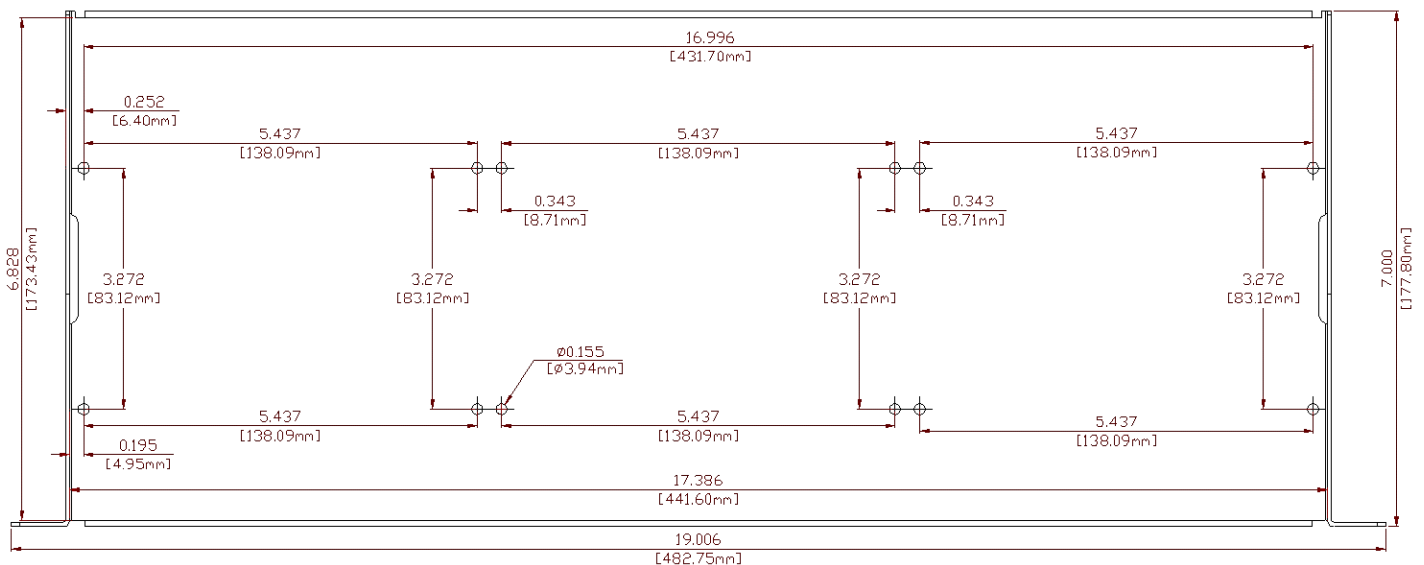

10.0 ORDERABLE INFORMATION

Part Number	Description
Ai429TST-ES04	4Tx/4Rx channels ARINC 429 tester class, RS-232/422 serial model, Gig Ethernet
Ai429TST-EU04	4Tx/4Rx channels ARINC 429 tester class, USB serial model, Gig Ethernet
Ai429TST-ES08	8Tx/8Rx channels ARINC 429 tester class, RS-232/422 serial model, Gig Ethernet
Ai429TST-EU08	8Tx/8Rx channels ARINC 429 tester class, USB serial model, Gig Ethernet
Ai429TST-ES12	12Tx/12Rx channels ARINC 429 tester class, RS-232/422 serial model, Gig Ethernet
Ai429TST-EU12	12Tx/12Rx channels ARINC 429 tester class, USB serial model, Gig Ethernet

11.0 MARKING

There are two marking: front and bottom. The front marking conveys the part number and used is to easily identify the product when installed in a rack/chassis. The bottom marking conveys the company information, serial

number, short description along with copyrights. The part number and the URL are also presented in scannable code.

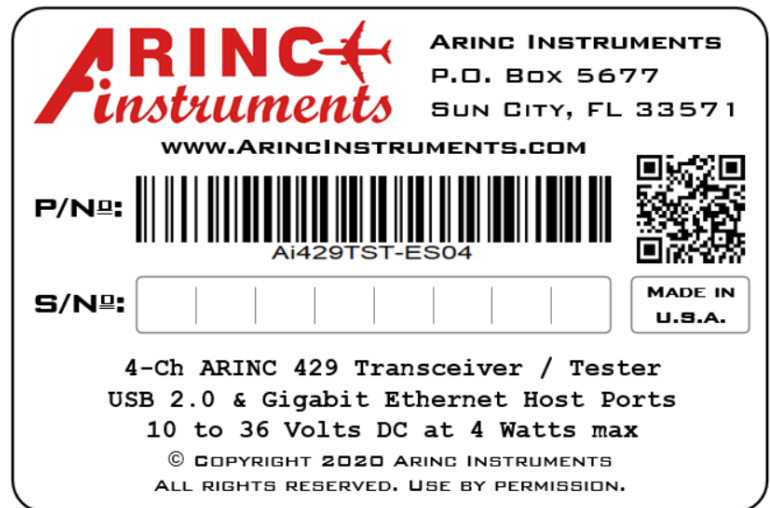

12.0 IMPORTANT NOTICE

Arinc Instruments (Ai) reserves the right to make corrections, enhancements, improvements and other changes to its products and services, latest issue, and to discontinue any product or service, latest issue. Buyers should obtain the latest relevant information before placing orders and should verify that such information is current and complete. Ai's published terms of sale (<http://www.ArincInstruments.com>) apply to the sale of products that Ai has qualified and released to market. Additional terms may apply to the use or sale of other types of Ai products and services.

Reproduction of significant portions of Ai information in Ai data sheets is permissible only if reproduction is without alteration and is accompanied by all associated warranties, conditions, limitations, and notices. Ai is not responsible or liable for such reproduced documentation. Information of third parties may be subject to additional restrictions. Resale of Ai products or services with statements different from or beyond the parameters stated by Ai for that product or service voids all express and any implied warranties for the associated Ai product or service and is an unfair and deceptive business practice. Ai is not responsible or liable for any such statements.

Buyers and others who are developing systems that incorporate Ai products (collectively, "Designers") understand and agree that Designers remain responsible for using their independent analysis, evaluation and judgment in designing their applications and that Designers have full and exclusive responsibility to assure the safety of Designers' applications and compliance of their applications (and of all Ai products used in or for Designers' applications) with all applicable regulations, laws and other applicable requirements. Designer represents that, with respect to their applications, Designer has all the necessary expertise to create and implement safeguards that (1) anticipate dangerous consequences of failures, (2) monitor failures and their consequences, and (3) lessen the likelihood of failures that might cause harm and take appropriate actions. Designer agrees that prior to using or distributing any applications that include Ai products, Designer will thoroughly test such applications and the functionality of such Ai products as used in such applications.

Ai's provision of technical, application or other design advice, quality characterization, reliability data or other services or information, including, but not limited to, reference designs and materials relating to evaluation modules, (collectively, "Ai Resources") are intended to assist designers who are developing applications that incorporate Ai products; by downloading, accessing or using Ai Resources in any way, Designer (individually or, if Designer is acting on behalf of a company, Designer's company) agrees to use any particular Ai Resource solely for this purpose and subject to the terms of this Notice.

Ai's provision of Ai Resources does not expand or otherwise alter Ai's applicable published warranties or warranty disclaimers for Ai products, and no additional obligations or liabilities arise from Ai providing such Ai Resources. Ai reserves the right to make corrections, enhancements, improvements and other changes to its Ai Resources. Ai has not conducted any testing other than that specifically described in the published documentation for a particular Ai Resource.

Designer is authorized to use, copy and modify any individual Ai Resource only in connection with the development of applications that include the Ai product(s) identified in such Ai Resource. NO OTHER LICENSE, EXPRESS OR IMPLIED, BY ESTOPPEL OR OTHERWISE TO ANY OTHER Ai INTELLECTUAL PROPERTY RIGHT,

AND NO LICENSE TO ANY TECHNOLOGY OR INTELLECTUAL PROPERTY RIGHT OF Ai OR ANY THIRD PARTY IS GRANTED HEREIN, including but not limited to any patent right, copyright, mask work right, or other intellectual property right relating to any combination, machine, or process in which Ai products or services are used. Information regarding or referencing third-party products or services does not constitute a license to use such products or services, or a warranty or endorsement thereof. Use of Ai Resources may require a license from a third party under the patents or other intellectual property of the third party, or a license from Ai under the patents or other intellectual property of Ai.

Ai RESOURCES ARE PROVIDED "AS IS" AND WITH ALL FAULTS. Ai DISCLAIMS ALL OTHER WARRANTIES OR REPRESENTATIONS, EXPRESS OR IMPLIED, REGARDING RESOURCES OR USE THEREOF, INCLUDING BUT NOT LIMITED TO ACCURACY OR COMPLETENESS, TITLE, ANY EPIDEMIC FAILURE WARRANTY AND ANY IMPLIED WARRANTIES OF MERCHANTABILITY, FITNESS FOR A PARTICULAR PURPOSE, AND NON-INFRINGEMENT OF ANY THIRD PARTY INTELLECTUAL PROPERTY RIGHTS. Ai SHALL NOT BE LIABLE FOR AND SHALL NOT DEFEND OR INDEMNIFY DESIGNER AGAINST ANY CLAIM, INCLUDING BUT NOT LIMITED TO ANY INFRINGEMENT CLAIM THAT RELATES TO OR IS BASED ON ANY COMBINATION OF PRODUCTS EVEN IF DESCRIBED IN Ai RESOURCES OR OTHERWISE. IN NO EVENT SHALL Ai BE LIABLE FOR ANY ACTUAL, DIRECT, SPECIAL, COLLATERAL, INDIRECT, PUNITIVE, INCIDENTAL, CONSEQUENTIAL OR EXEMPLARY DAMAGES IN CONNECTION WITH OR ARISING OUT OF Ai RESOURCES OR USE THEREOF, AND REGARDLESS OF WHETHER Ai HAS BEEN ADVISED OF THE POSSIBILITY OF SUCH DAMAGES.

Unless Ai has explicitly designated an individual product as meeting the requirements of a particular industry standard, Ai is not responsible for any failure to meet such industry standard requirements.

Where Ai specifically promotes products as facilitating functional safety or as compliant with industry functional safety standards, such products are intended to help enable customers to design and create their own applications that meet applicable functional safety standards and requirements. Using products in an application does not by itself establish any safety features in the application. Designers must ensure compliance with safety-related requirements and standards applicable to their applications. Designer may not use any Ai products in life-critical medical equipment unless authorized officers of the parties have executed a special contract specifically governing such use. Life-critical medical equipment is medical equipment where failure of such equipment would cause serious bodily injury or death (e.g., life support, pacemakers, defibrillators, heart pumps, neurostimulators, and implantable). Such equipment includes, without limitation, all medical devices identified by the U.S. Food and Drug Administration as Class III devices and equivalent classifications outside the U.S.

Ai may expressly designate certain products as completing a particular qualification. Designers agree that it has the necessary expertise to select the product with the appropriate qualification designation for their applications and that proper product selection is at Designers' own risk. Designers are solely responsible for compliance with all legal and regulatory requirements in connection with such selection.

Designer will fully indemnify Ai and its representatives against any damages, costs, losses, and/or liabilities arising out of Designer's noncompliance with the terms and provisions of this Notice.

Mailing Address: Arinc Instruments, Post Office Box 5677, Sun City Florida, 33571